

Model: RP-AP088W
RP-AP088B

RENPHO

Air Purifier

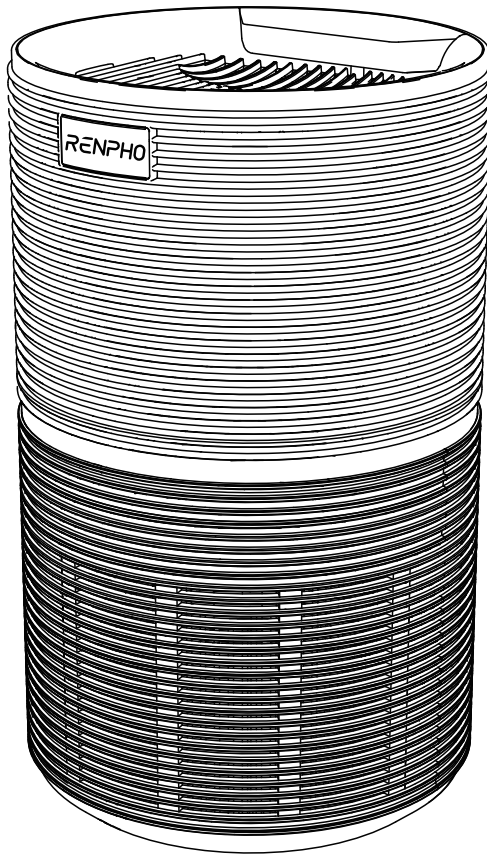

Thank you for choosing RENPHO!
Whether at home or in the office,
this air purifier brings you fresh air.

FCC Regulatory Compliance

This device complies with part 15 of the FCC Rules. Operation is subject to the following two conditions: (1) This device may not cause harmful interference, and (2) this device must accept any interference received, including interference that may cause undesired operation.

Warning: changes or modifications not expressly approved by the party responsible for compliance could void the user's authority to operate the equipment.

Note: This equipment has been tested and found to comply with the limits for a Class B digital device, pursuant to Part 15 of the FCC Rules. These limits are designed to provide reasonable protection against harmful interference in a residential installation. This equipment generates, uses and can radiate radio frequency energy and, if not installed and used in accordance with the instructions, may cause harmful interference to radio communications.

However, there is no guarantee that interference will not occur in a particular installation.

If this equipment does cause harmful interference to radio or television reception, which can be determined by turning the equipment off and on, the user is encouraged to try to correct the interference by one or more of the following measures:

- Reorient or relocate the receiving antenna.
- Increase the separation between the equipment and receiver.
- Connect the equipment into an outlet on a circuit different from that to which the receiver is connected.
- Consult the dealer or an experienced radio/TV technician for help.

ISED Regulatory compliance

This device complies with Industry Canada licence-exempt RSS standard(s).

Operation is subject to the following two conditions: (1) This device may not cause interference, and (2) This device must accept any interference, including interference that may cause undesired operation of the device.

Le présent appareil est conforme aux CNR d'Industrie Canada applicables aux appareils radio exempts de licence. L'exploitation est autorisée aux deux conditions suivantes:

- (1) l'appareil ne doit pas produire de brouillage, et
- (2) l'utilisateur de l'appareil doit accepter tout brouillage radioélectrique subi, même si le brouillage est susceptible d'en compromettre le fonctionnement.

Contents

1. Specifications & Package	01
2. Safety Instructions.....	02
3. Product Structure	04
4. Before First Use	05
5. Using The Appliance	07
6. Filter Replacement	09
7. Clean Air Purifier	11
8. Storage	11
9. Environment	11
10. Troubleshooting	12
11. Warranty Policy	13
12. Customer Service	13

Specifications

Input	AC 120V 60Hz (US&CA) 220-240VAC 50-60Hz (AU)
Rated Power	32W (US&CA) 35W (AU)
Operating Conditions	Temperature: 23°F~108°F(-5°C~42°C)
Noise Level	26-52dB
Clean Air Delivery Rate (CADR)	100CFM (170 m ³ /h)

What's Included

Your RENPHO Air Purifier box includes

- 1x RENPHO Air Purifier
- 1x User Manual

Safety Information

IMPORTANT: Please read and comply with all of the instructions and warnings mentioned in this manual before using the product. Failure to comply with the instructions and warnings provided herein may result in inaccurate results and/or damage to the product itself.

Danger

- **Do not** let water or any other liquid or flammable detergent enter the appliance to avoid electric shock and/or a fire hazard.
- **Do not** clean the appliance with water or any other liquid or a (flammable) detergent to avoid electric shock and/or a fire hazard.

Warning

- Check if the voltage indicated on the bottom of the appliance corresponds to the local mains voltage before you connect the appliance.
- If the mains cord is damaged, you must have it replaced by distributor, or a service center authorized by distributor or similarly qualified persons in order to avoid a hazard.
- **Do not** use the appliance if the plug, the mains cord or the appliance itself is damaged.
- This appliance is not intended for use by persons (including children) with reduced physical, sensory or mental capabilities, or lack of experience and knowledge, unless they have been given supervision or instruction concerning use of the appliance by a person responsible for their safety.
- Children should be supervised to ensure that they do not play with the appliance.
- **Do not** block the air inlet and outlet, e.g. by placing items on the air outlet or in front of the air inlet.

Caution

- This appliance is not a substitute for proper ventilation, regular vacuum cleaning or use of an extractor hood or fan while cooking.
- If the wall socket used to power the appliance has poor connections, it will cause the plug of the appliance to overheat. Make sure you plug the appliance into a properly connected wall socket.
- Always place and use the appliance on a dry, stable, level and horizontal surface.
- There should be at least 40cm free space around or above the appliance.
- **Do not** place anything on top of the appliance and do not sit on the appliance.
- **Do not** place the appliance directly below an air conditioner to prevent condensation from dripping onto the appliance.

- Make sure all filters are properly installed before you switch on the appliance.
- Only use the original filters specially intended for this appliance. Do not use any other filters.
- Avoid knocking against the appliance (the air inlet and outlet in particular) with hard objects.
- Always lift or move the appliance by the handle at the back of the appliance.
- **Do not** insert your fingers or objects into the air outlet.
- **Do not** use this appliance when you have used indoor smoke-type insect repellents or in places with oily residues, burning incense or chemical fumes.
- **Do not** use the appliance near gas appliances, heating devices or fireplaces.
- Always unplug the appliance after use and before you clean it.
- **Do not** use the appliance in a room with major temperature changes, as this may cause condensation inside the appliance.
- The appliance is only intended for household use under normal operating conditions.
- **Do not** use the appliance in wet surroundings or in surroundings with high ambient temperatures.
- The appliance does not remove carbon monoxide (CO) or radon (Rn). It cannot be used as a safety device in case of accidents with combustion processes and hazardous chemicals.
- To prevent radio interference, the appliance should be kept at least 2 meters away from any device that uses radio waves.

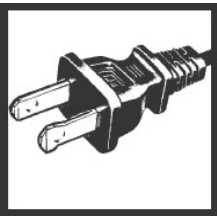

THIS APPLIANCE HAS A POLARIZED PLUG(one blade is wider than the other).To reduce the risk of electric shock,this plug is intended to fit in a polarized outlet only one way.If the plug does not fit fully in the outlet,reverse the plug.If it still does not fit,contact a qualified electrician to install the proper outlet.



DO NOT ATTEMPT TO MODIFY THIS PLUG OR DEFEAT THIS SAFETY FEATURE IN ANY WAY.

Product Structure

Welcome using our air purifier. Before use please read this manual carefully to operate the product correctly.

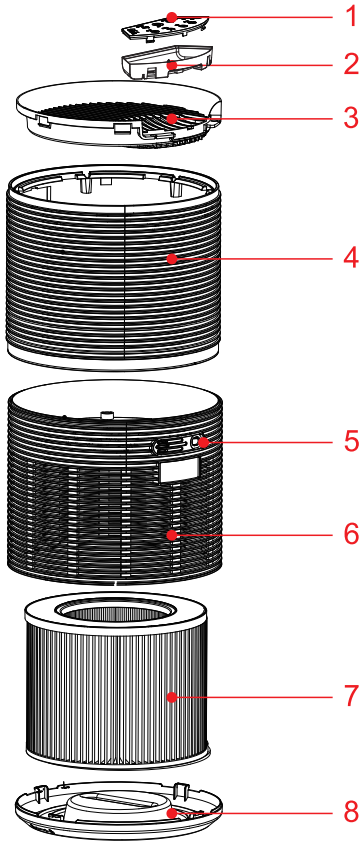

1. Touch-Control Panel
2. Night Light
3. Air Outlet
4. Upper Body
5. Power Cord
6. Air Inlet
7. H13 True HEPA 5-stage Filter
8. Base Cover

Before First Use

Placing the filters

The appliance comes with all filters fitted inside. Please take off packing of the filter before use. Remove all filters, unpack them and place them back into the appliance as described below

Note: Make sure you insert the filters in the correct position.

1. Put the appliance upside down on a soft cloth to avoid scratching. To open the base cover, you need to find an arrow point ▲ on the base cover corresponding the **LOCK** position. Turn the base cover counterclockwise from **LOCK** to **OPEN** position, then the lock is released.

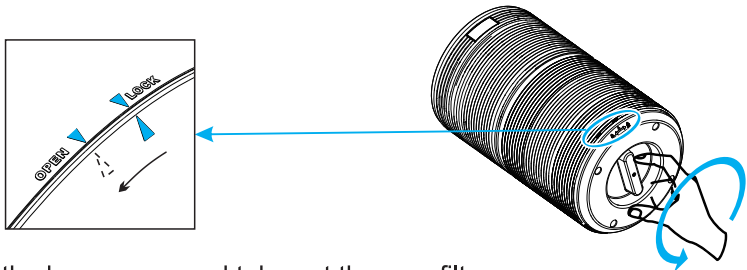

2. Remove the base cover and take out the new filter.

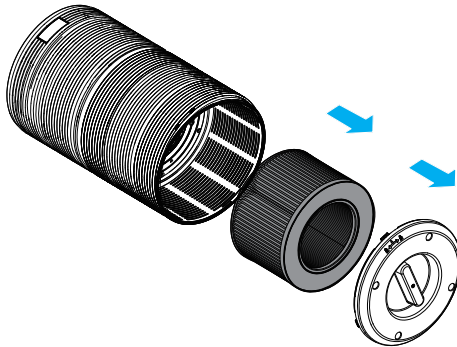

3. Remove the Plastic Packaging from the filter.

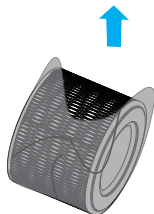

4. Put the filter back into the appliance.

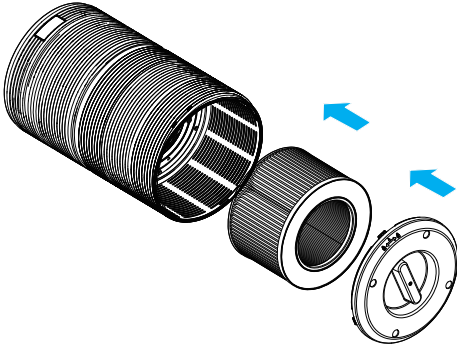

5. Turn the base cover clockwise from **OPEN** position to **LOCK** position. You will hear a "click" sound, the base cover is fastened.

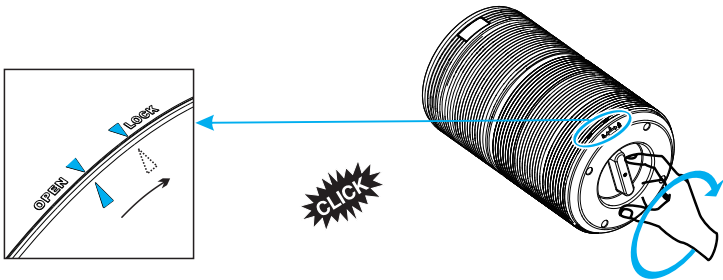

Using The Appliance

About the control panel

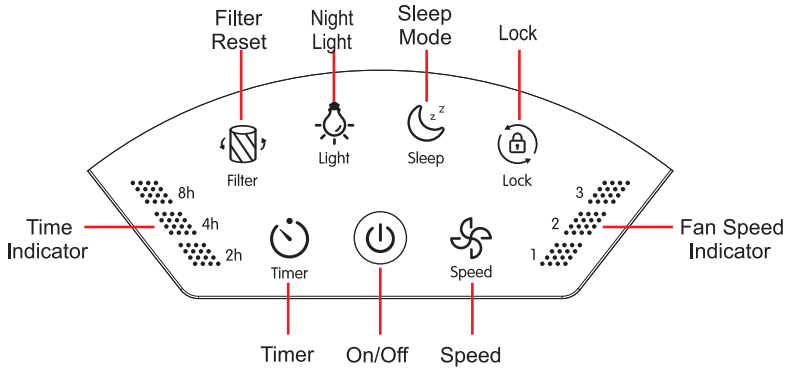

1. Put the plug in the wall socket

All lights will turn on at once and you will hear a beep.

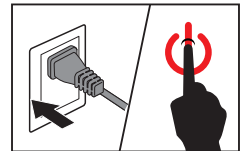

2. Press the power button to switch on the appliance.

Press  button, Night light turns on and speed runs at level 2.





3. Fan speed adjustment

The fan speed light indicates at which fan speed the appliance is operating. Press Speed button  to adjust fan speed level. There are three levels.

1~3 refers to **Low, Medium, High**.

Tips: When the appliance is switched on, the fan speed is at the medium level.





4. Sleep mode

When the appliance is in Sleep Mode, it works very quietly. Only the  and  buttons (If setting the timer) will be at half brightness. All other buttons' light will be off. Press any other buttons(except  and  buttons) to exit the sleep mode.



5. Light

When the purifier is powered on, the light displays white.



>> Working status

- 1) Turn on the purifier and then the bright-white light will be opened by default and the breathing mode is turned on as well.
- 2) Short press the  button, change to bright-white; then short press once, change to half-bright white; short press once, change to colorful gradient mode; and short press again, turn off the light.
- 3) Long press  button 3 seconds, and the breathing mode is turned on. And long press 3 seconds, turn off it.
- 4) In colorful gradient status, long press  button 3 seconds. The lights stay on (red, orange, yellow, green, cyan, blue, purple), without breathing mode. Then long press  3 seconds and the breathing mode is turned on.



>> Standby status

Night color is orange and cold-white. Press  button turn on night light, the light is orange with half-light and you will hear a "beep" sound. Then press  button again, night light enters the cycle in order by fully bright → cold white, half bright → fully bright → turn off → orange, half bright...

6. Setting timer

1. Press  to turn on or off the timer, and to cycle through timer options (2 hours, 4 hours, or 8 hours).
 2. The air purifier will automatically power off once the timer is finished.
- NOTE: Pressing  or unplugging the air purifier will cancel the timer.

7. Keylock mode

- 1) Press  button to activate Keylock mode, all buttons are locked at this mode; If your house has young child, we suggest using this mode.
- 2) To cancel the keylock mode, just press and hold  button for 3 seconds.

8. Filter replacement light

When indicator  lights, it means that you should check the filter to see if it needs to be cleaned or replaced.

Note: The filter's lifetime is based to your house air quality and using time. Using the appliance in a humid environment will reduce the lifetime of the filter.

9. Memory Function

When the air purifier is plugged in, it will remember its previous fan speed setting.

Filter Replacement

>> When Should I Replace the Air Filter?

It is recommended to change the air filter every 6–8 months. However, you may need to change your filter sooner or later depending on how often you use your air purifier and your house air quality. It is important to watch out for the following signs of expired filter:

- Increased operating noise
- Decreased airflow
- Clogged filter
- Increased presence of odors

NOTE:

- The environment in which the air purifier being used may also extend or shorten the lifetime of the the air filter. Using your air purifier in an environment of heavy pollution may mean you will need to change the air filter more often.
- If the air pollution in your environment is very high, there is a possibility that the filters may not be completely effective and may need to be replaced before  lights up.
- Remember to reset the air purifier after changing the air filter.
- Using the appliance in a humid environment will reduce the lifetime of activated carbon filter and HEPA filter.

Tip: Only use Official RENPHO replacement parts to maintain product performance.(Search for: RP-AP088-F1/F2)

>> How to replace the Air Filter?

1. Switch off the appliance and unplug it. (a)
2. Put the appliance upside down on a soft cloth to avoid scratching.To open the base cover, you need to find an arrow point ▲ on the base cover corresponding the **LOCK** position.Turn the base cover counterclockwise from **LOCK** to **OPEN** position, then the base cover is released. (b)

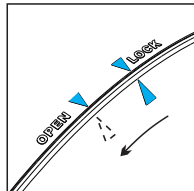
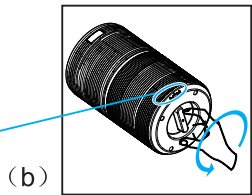
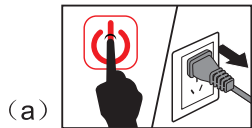

3. Remove the old filter. (c)

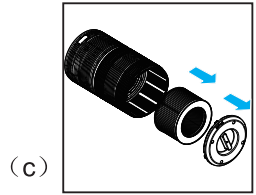

4. Remove the packaging material of the new filter. (d)

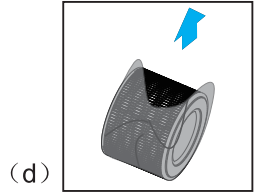

5. Put the new filter back into the appliance. (e)

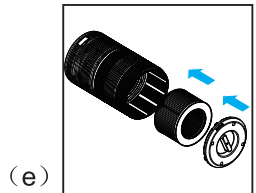

6. Turn the base cover clockwise from **OPEN** position to **LOCK** position, and you will hear a "click" sound. The base cover is fastened. (f)

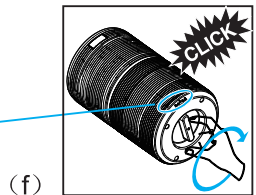
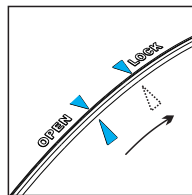

7. Put the plug in the wall socket and switch on the appliance again. (g)

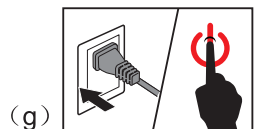

8. Reset Filter's lifetime.

After replacing the filters, when you switch on the appliance, '⊞' the replace filter light still lights up. You need to reset the filter's lifetime sensor, so that the appliance can calculate the filters' lifetime.

- 1). Plug in the air purifier and turn it on.
- 2). Press and hold '⊞' for 3 seconds.
- 3). Release '⊞' and the light will turn off, indicating that the reset is completed.

(h)

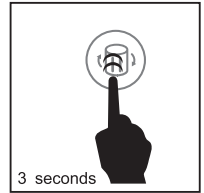

>> Filter Replacement Force Mode

When using the air purifier in an environment of heavy pollution, the lifespan of the air filter may be significantly reduced. You can change the filters even if '⊞' does not light up. Follow the steps below to perform a hard reset.

- 1). Replace the air filters as mentioned in the Filter Replacement section.
- 2). Plug in the air purifier and keep in standby mode.
- 3). Press and hold '⊞' for 3 seconds, and it will light up.
- 4). Press and hold '⊞' again for 3 seconds, and it will turn off. The reset is now completed.

Clean Air Purifier

In order to keep your purifier working with more efficiency and life-time, clean the filter (pre-filter side only) every 2 weeks following the Instruction Below:

- 1). Clean out any dust, hair, or furs remaining on the pre-filter by using the vacuum hose.
- 2). Clean out any dust, hair, or furs remaining on the bottom cover by using the vacuum hose.
- 3). DO NOT wash the filter with any water or liquid.

Storage

Unplug the power cord, then wipe the machine clean, put the appliance in the packing bag, then put it in a dry place.

Environment

Do not throw away the appliance with the normal household waste at the end of its life, but hand it in at an official collection point for recycling. By doing this, you help to preserve the environment.

Troubleshooting

This chapter summarizes the most common problems you could encounter with the appliance. If you are unable to solve the problem with the information below, contact us directly via e-mail at: support@renpho.com or phone: +1(844)417-0149

Problem	Cause	Solution
Air purifier does not power on.	Unit is not plugged into an electrical outlet.	Connect the plug to a powered electrical outlet.
	Outlet is not working properly.	Try plugging the air purifier into a different outlet.
	Power button has not been pressed after plugging in the air purifier.	Press '⏻' once to turn on the air purifier.
	Power cord is damaged.	Immediately discontinue use and contact Customer Support .
	Air purifier is defective or malfunctioning.	
Air purifier does not respond to button controls.	Air purifier is not plugged into an outlet.	Connect the plug to a powered electrical outlet.
	Air purifier is defective or malfunctioning.	Immediately discontinue use and contact Customer Support.
Air purifier makes an unusual noise while operating.	Filter is dirty.	Replace the air filter as instructed in the Filter Replacement section.
	Filter does not fit properly.	Properly place filter as noted in the Before first use and Filter Replacement sections.
	Foreign object inside the unit.	Immediately discontinue use and contact Customer Support. DO NOT attempt to open the air purifier.
	Filter packaging has not been removed.	Remove filter from packaging before use.
Significantly reduced airflow.	Filter packaging has not been removed.	Remove filter from packaging before use.
	Fan speed is low.	Press '🌀' to adjust fan speed.
	Filter needs to be replaced.	Replace the air filters as instructed in the Filter Replacement section.
	Not enough clearance on all sides of the purifier.	Ensure there is at least 38 cm (15 inches) of clearance on all sides of the purifier.
Poor air purification quality.	Filter needs to be replaced.	Replace the air filters as instructed in the Filter Replacement section.
	Room is too large for the air purifier's.	Ensure the room is smaller than applicable area.
	Air inlet or outlet is blocked.	Remove objects blocking air inlet or outlet.
	Filter not properly placed in housing.	Properly place filters as noted in the Before first use and Filter Replacement sections.
Filter reset button is still illuminated after replacing the air filter.	The air purifier has been reset incorrectly.	See the Filter Replacement section on how to properly reset the unit.
Air purifier turns on, then suddenly turns off.	Air purifier is defective or malfunctioning.	Immediately discontinue use and contact Customer Support. DO NOT attempt to open the air purifier for self-servicing.
Air purifier beeps repeatedly after being powered on or plugged in.		

Warranty Policy

Your RENPHO product purchase is covered by a one-year limited manufacturer warranty from the date of delivery.

For warranty terms and conditions, please visit:

<https://renpho.com/pages/warranty-terms-and-conditions>

Note: Product registration is not required for the warranty.

If you choose not to register your product, it will not diminish the product warranty.

Customer Service

Please feel free to contact us if you have any questions or concerns. RENPHO Customer Service Team guarantees a quick response and hassle-free solutions to any issue you may have within business hours.

TEL: +1(844) 417 0149 (US ONLY)

Monday-Friday 9:00AM-4:30PM

1800 MY RENPHO (1800 69 7367) (AU ONLY)

Monday-Friday 9:00AM-5:00PM (GMT+10)

Email: support@renpho.com (US&CA)

support-au@renpho.com (AU)

*For defective products or the return of items, please contact us with your order number within the specified warranty period. DO NOT dispose of any product parts as they may be required for inspection/repair.

US Importer: JOICOM CORPORATION

14129 The Merge Street, Building 3 Unit A, Eastvale, CA 92880

Manufacturer: Shenzhen Ruiyi Business Technology Co., Ltd.

Qianhai Complex A201, Qianwan Road 1, Qianhai Shenzhen-Hong Kong Cooperation Zone, Shenzhen, P.R.China

Made in China

NA5